

LAMA INTERAMENTE BONIFICATA CON PUNTA BRUNITA,
IMPUGNATURA IN POLIPROPILENE

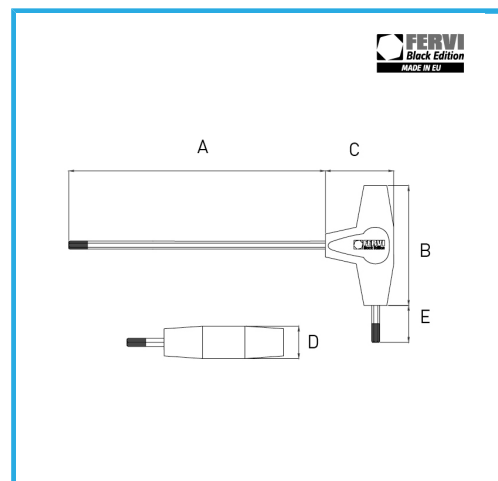

€5,04



Misura	4 mm
A	125 mm
B	45 mm
C	32 mm
D	15,5 mm
E	15 mm
Codice EAN	8012667303464

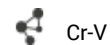

Cr-V



Cromata



Appendibile